

## Modular Balustrade Cross Bar Holder Centre Connector Flat - Bar

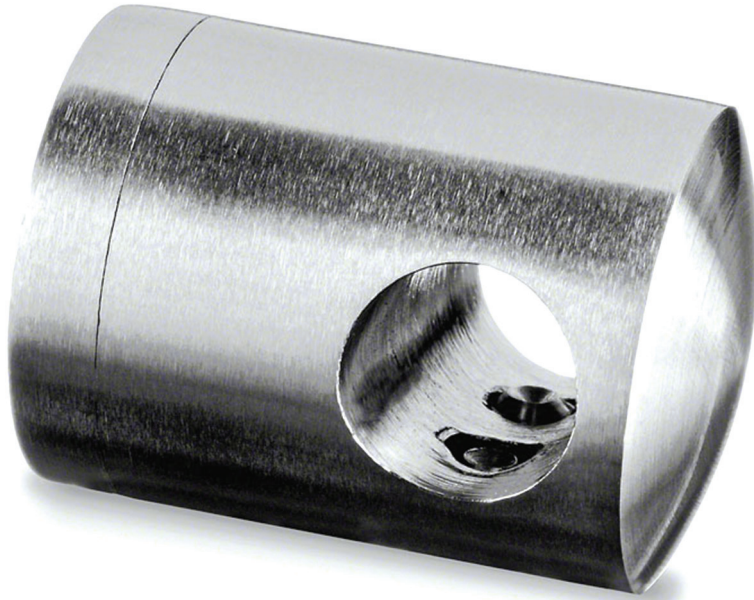

### MOD 0831

Flat fixing cross bar holder designed to meet and hold 12mm tubular stainless steel bars as balustrade infill.

Available for interior (304 grade) and exterior (316 grade) applications, the flat fix is perfect for installation on walls or square sections of stainless steel.

Finished to a superb brushed 320 grit satin.

Simple to install with the use of a drill and hex head key.

### Modular Range

Our most comprehensive and popular range of balustrade components. Produced from high quality stainless steel ensuring your installation is of the highest quality and will stand the test of time.

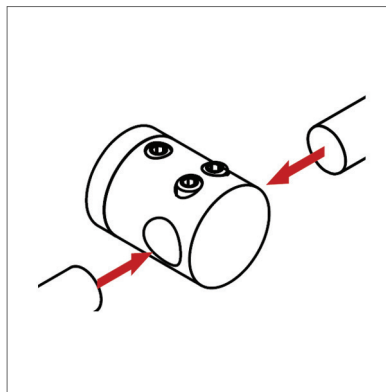
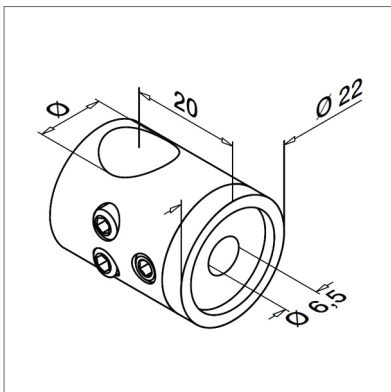

### Product Information

Available options

Grade: 304 (interior) stainless steel.  
Grade: 316 (exterior) stainless steel.

Bar Diameter: 12mm  
Stand Off Height  
To Hole Centre: 20mm  
To a brushed 320 grit satin finish.

### Key Features

**304** Available in 304 grade (interior) stainless steel.

**316** Available in 316 grade (exterior) stainless steel.



This product requires a hex head key for installation.



This product requires M6 x 25 Countersunk Hex Head Screw.



Drill required for installation.



To a superb brushed 320 grit satin finish.

## Modular Balustrade Cross Bar Holder Centre Connector Flat - Bar

### Cross Bar Installation



Mark hole position on post.  
A small piece of masking tape will help with this. Drill 5mm diameter hole.



Tap the 5mm hole with M6 tap.

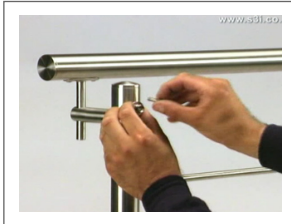

Fix to the post with M6 countersunk screw.

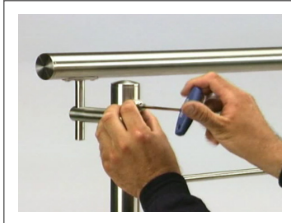

Tighten with hex head key.



Insert rod into holder.

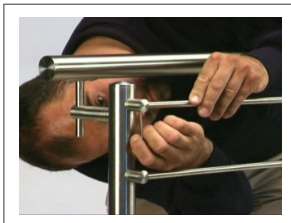

Secure with grub screw using hex head key.

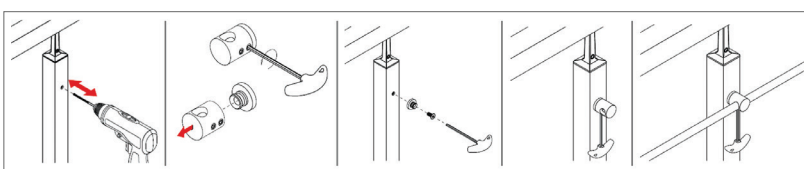

### Tools and Fixings

We carry a large selection of balustrade accessories that you may need for the installation of your stainless steel balustrade. These are designed to work with all our various ranges of stainless steel balustrade.



**M6 x 25 Countersunk Hex Head Screw.**



This product requires a **hex head key** for installation.

### Care Instructions



We recommend you should treat your stainless steel balustrade on a regular basis to ensure long-lasting perfection.

We recommend using either WD-40 or a similar product to wipe down your stainless steel or using a specialist chemical stainless steel cleaner to remove heavy dirt and rust stains.

**Q-Ultra-Clean** rebuilds and strengthens the passive layer of stainless steel.

### Design

You can send us your drawings, technical drawings or even a freehand sketch.

From this we'll produce an accurate quotation for you. This service is completely free with no hassle or obligation.

Give us a call for any advice Monday to Friday 9.00am to 5.00pm

Contact us

Email: [info@s3i.co.uk](mailto:info@s3i.co.uk)

Telephone: **01302 752 504**