

Stainless Steel Tube - 48.3mm Diameter



This finest quality 48.3mm diameter stainless steel tube forms the posts and handrail of your balustrade. We can cut and finish this product to any desired length up to 5 metres. It has a strong wall thickness of 2mm and the 48.3mm diameter matches the rest of the modular balustrade range perfectly.

Please note that lengths over 3 metres will attract a long length delivery surcharge.

Modular DIY Range

Our most comprehensive and popular range of balustrade components. Produced from high quality 304 grade stainless steel with choices of tube diameters 42.4mm or 48.3mm..

Product Information

Available Options

Tube diameter: 48.3mm

Grade: 304 (interior) stainless steel.

Grade: 316 (exterior) stainless steel.

Wall Thickness: 2mm

Length up to 5 metres

:Brushed 320 grit satin finish.

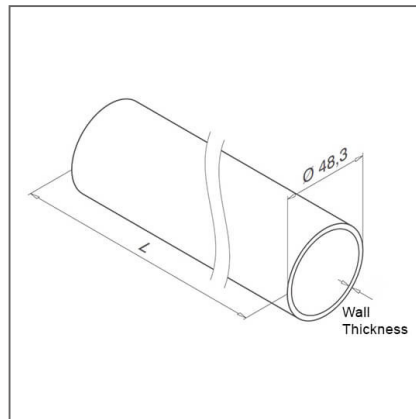
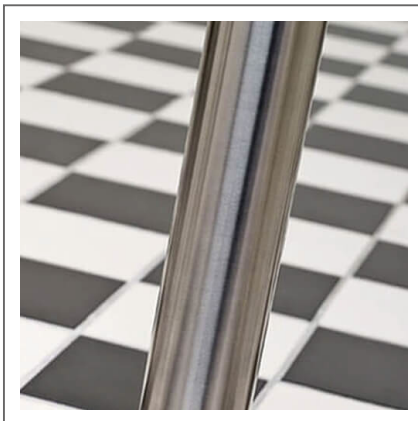

Key Features

304

Manufactured from 304 grade stainless steel.

316

Manufactured from 316 grade stainless steel.

Ø 48.3

To fit 48.3mm diameter stainless steel tube.



Brushed 320 grit satin finish.

Care Instructions



We recommend you should treat your stainless steel tube on a regular basis to ensure long-lasting perfection.

We recommend using either WD-40 or a similar product to wipe down your tube, or using a specialist chemical stainless steel cleaner to remove heavy dirt and rust stains.

Q-Ultra-Clean rebuilds and strengthens the passive layer of stainless steel.

Design

You can send us your drawings, technical drawings or even a freehand sketch.

From this we'll produce an accurate quotation for you. This service is completely free with no hassle or obligation.

Give us a call for any advice Monday to Friday 9.00am to 5.00pm

Contact us

Email: info@s3i.co.uk

Telephone: **01302 752 504**